

### Medium Power Thyristors (Stud Version), 25A



#### FEATURES

- Improved glass passivation for high reliability and exceptional stability at high temperature
- High di/dt and dV/dt capabilities
- Standard package
- Low thermal resistance
- Metric threads version available
- Types up to 1600 V  $V_{DRM}/V_{RRM}$
- RoHS compliant
- Designed and qualified for industrial and consumer level



TO-208AA(TO-48)

#### TYPICAL APPLICATIONS

- Medium power switching
- Phase control applications
- Can be supplied to meet stringent military, aerospace and other high reliability requirements

PRODUCT SUMMARY	
$I_{T(AV)}$	25A

MAJOR RATINGS AND CHARACTERISTICS			
PARAMETER	TEST CONDITIONS	VALUES	UNITS
$I_{T(AV)}$		25	A
	$T_C$	85	°C
$I_{T(RMS)}$		40	A
$I_{TSM}$	50 HZ	420	A
	60 HZ	440	
$I^2t$	50 HZ	882	A <sup>2</sup> s
	60 HZ	804	
$V_{DRM}/V_{RRM}$		600 to 1600	V
$t_q$	Typical	110	μS
$T_J$		-65 to 125	°C

#### ELECTRICAL SPECIFICATIONS

VOLTAGE RATINGS				
TYPE NUMBER	VOLTAGE CODE	$V_{DRM}/V_{RRM}$ , MAXIMUM AND OFF-STATE VOLTAGE <sup>(1)</sup> V	$V_{RSM}$ , MAXIMUM NON-REPETITIVE PEAK VOLTAGE <sup>(2)</sup> V	$I_{DRM}/I_{RRM}$ , MAXIMUM AT $T_J = T_J$ MAXIMUM mA
25PTS	06	600	700	10
	08	800	900	
	10	1000	1100	
	12	1200	1300	
	16	1600	1700	

#### Note

- (1) Units may be broken over non-repetitively in the off-state direction without damage, if di/dt does not exceed 20 A/μs  
 (2) For voltage pulses with  $t_p \leq 5$  ms

FORWARD CONDUCTION					
PARAMETER	SYMBOL	TEST CONDITIONS		VALUES	UNITS
Maximum average forward current at case temperature	$I_{T(AV)}$	180° conduction, half sine wave		25	A
				85	°C
Maximum RMS forward current	$I_{T(RMS)}$			40	A
Maximum peak, one-cycle non-repetitive surge current	$I_{TSM}$	t = 10ms	No voltage reappplied	420	A
		t = 8.3ms	No voltage reappplied	440	
		t = 10ms	100% $V_{RRM}$ reappplied	350	
		t = 8.3ms	100% $V_{RRM}$ reappplied	370	
Maximum $I^2t$ for fusing	$I^2t$	t = 10ms	No voltage reappplied	882	$A^2s$
		t = 8.3ms	No voltage reappplied	804	
		t = 10ms	100% $V_{RRM}$ reappplied	625	
		t = 8.3ms	100% $V_{RRM}$ reappplied	569	
Maximum $I^2\sqrt{t}$ for fusing	$I^2\sqrt{t}$	t = 0.1 to 10 ms, no voltage reappplied, $T_J = T_J$ maximum		8820	$A^2\sqrt{s}$
Low level value of threshold voltage	$V_{T(TO)1}$	$(16.7\% \times \pi \times I_{T(AV)} < I < \pi \times I_{T(AV)})$ , $T_J = T_J$ maximum		0.99	V
High level value of threshold voltage	$V_{T(TO)2}$	$(I > \pi \times I_{T(AV)})$ , $T_J = T_J$ maximum		1.40	
Low level value of on-state slope resistance	$r_{t1}$	$(16.7\% \times \pi \times I_{T(AV)} < I < \pi \times I_{T(AV)})$ , $T_J = T_J$ maximum		10.1	mΩ
High level value of on-state slope resistance	$r_{t2}$	$(I > \pi \times I_{T(AV)})$ , $T_J = T_J$ maximum		5.7	
Maximum on-state voltage	$V_{TM}$	$I_{pk} = 79$ A, $T_J = 25^\circ C$		1.70	V
Maximum holding current	$I_H$	$T_J = 25^\circ C$ , anode supply 6 V, resistive load		130	mA
Latching current	$I_L$			200	

SWITCHING					
PARAMETER	SYMBOL	TEST CONDITIONS		VALUES	UNITS
Maximum rate of rise of turned-on current	$di/dt$	$T_J = T_J$ maximum, $V_{DM} = 2/3 V_{DRM}$ , $t_p = 200 \mu s$ , $I_G = 0.3A$ , $dI_G/dt = 0.3 A/\mu s$ , $T_J = 125^\circ C$		150	$A/\mu s$
Typical turn-on time	$t_{gt}$	$T_J = 25^\circ C$ , at rated $V_{DRM}/V_{RRM}$ , $T_J = 125^\circ C$		0.9	$\mu s$
Typical reverse recovery time	$t_{rr}$	$T_J = T_J$ maximum, $I_{TM} = I_{T(AV)}$ , $t_p > 200 \mu s$ , $dI/dt = -10 A/\mu s$		4	
Typical turn-off time	$t_q$	$T_J = T_J$ maximum, $I_{TM} = I_{T(AV)}$ , $t_p > 200 \mu s$ , $V_R = 100$ V, $dI/dt = -10 A/\mu s$ , $dV/dt = 20 V/\mu s$ linear to 67% $V_{DRM}$ , gate bias 0 V to 100 V		110	

**Note**

$t_q = 10 \mu s$  up to 600 V,  $t_q = 30 \mu s$  up to 1600 V available on special request

BLOCKING					
PARAMETER	SYMBOL	TEST CONDITIONS		VALUES	UNITS
Maximum critical rate of rise of off-state voltage	$dV/dt$	$T_J = T_J$ maximum linear to 67% rated $V_{DRM}$ , gate open		1000	$V/\mu s$

TRIGGERING					
PARAMETER	SYMBOL	TEST CONDITIONS		VALUES	UNITS
Maximum peak gate power	$P_{GM}$	$T_J = T_J$ maximum		8.0	W
Maximum average gate power	$P_{G(AV)}$			2.0	
Maximum peak positive gate current	$I_{GM}$	$T_J = T_J$ maximum		1.5	A
Maximum peak negative gate voltage	$-V_{GM}$	$T_J = T_J$ maximum		10	V
DC gate current required to trigger	$I_{GT}$	$T_J = -65^{\circ}\text{C}$	Maximum required gate trigger current/voltage are the lowest value which will trigger all units 6 V anode to cathode applied	90	mA
		$T_J = 25^{\circ}\text{C}$		60	
		$T_J = 125^{\circ}\text{C}$		35	
DC gate voltage required to trigger	$V_{GT}$	$T_J = -65^{\circ}\text{C}$		3.0	V
		$T_J = 25^{\circ}\text{C}$		1.5	
		$T_J = 125^{\circ}\text{C}$		1.0	
DC gate current not to trigger	$I_{GD}$	$T_J = T_J$ maximum, $V_{DRM} = \text{Rated value}$		2.0	mA
DC gate voltage not to trigger	$V_{GD}$	$T_J = T_J$ maximum, $V_{DRM} = \text{Rated value}$	Maximum gate current/voltage not to trigger is the maximum value which will not trigger any unit with rated $V_{DRM}$ anode to cathode applied	0.2	V

THERMAL AND MECHANICAL SPECIFICATIONS					
PARAMETER	SYMBOL	TEST CONDITIONS		VALUES	UNITS
Maximum junction operating and storage temperature range	$T_J, T_{stg}$			- 65 to 125	$^{\circ}\text{C}$
Maximum thermal resistance, junction to case	$R_{thJC}$	DC operation		0.75	K/W
Maximum thermal resistance case to heatsink	$R_{thCS}$	Mounting surface, smooth, flat and greased		0.35	
Allowable mounting torque		Not-lubricated threads		$3.4^{+0}_{-10\%}$ (30)	N · m (lbf · in)
		Lubricated threads		$23^{+0}_{-10\%}$ (20)	N · m (lbf · in)
Approximate weight				11.5	g
				0.41	oz.
Case style		See dimensions - link at the end of datasheet		TO-208AA (TO-48)	

$\Delta R_{thJC}$ CONDUCTION					
CONDUCTION ANGEL	SINUSOIDAL CONDUCTION	RECTANGULAR CONDUCTION		TEST CONDUCTIONS	UNITS
180°	0.17	0.13		$T_J = T_J$ maximum	K/W
120°	0.21	0.22			
90°	0.27	0.30			
60°	0.40	0.42			
30°	0.69	0.70			

**Note**

- The table above shows the increment of thermal resistance  $R_{thJC}$  when devices operate at different conduction angles than DC

**Fig.1 Current ratings characteristics**

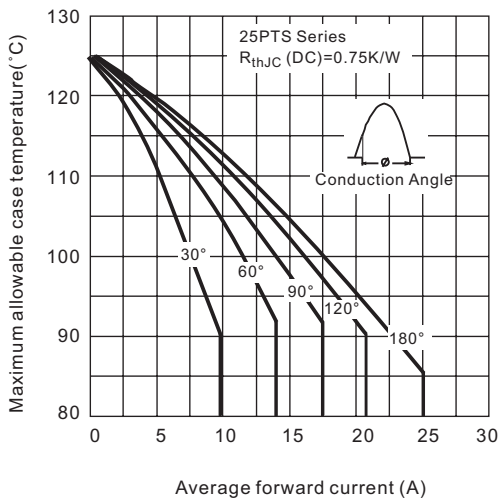

**Fig.2 Current ratings characteristics**

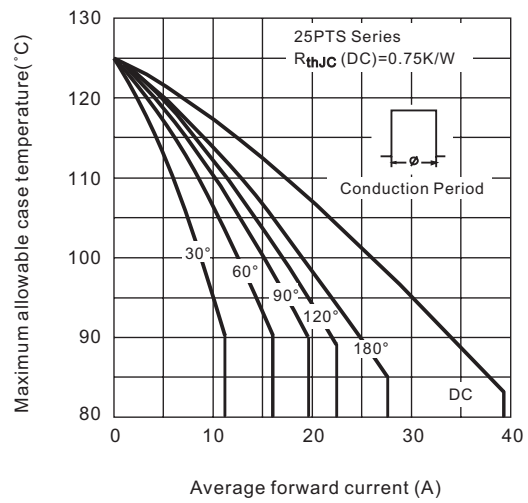

**Fig.3 On-state power loss characteristics**

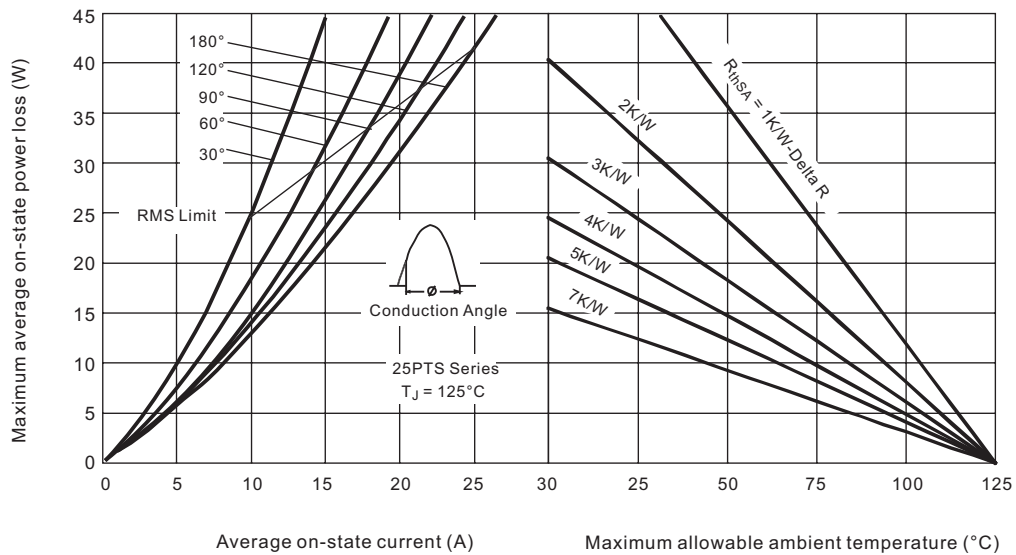

**Fig.4 On-state power loss characteristics**

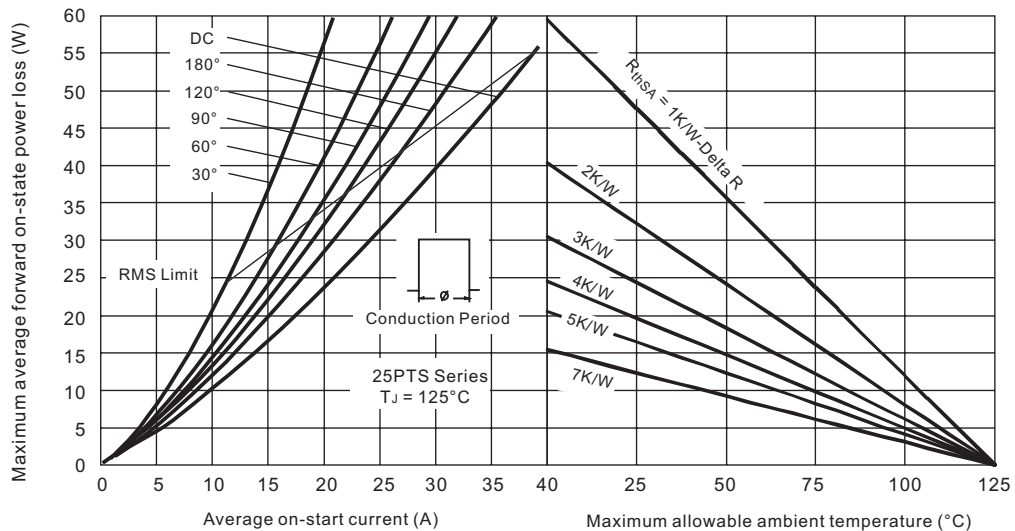

**Fig.5 Maximum non-repetitive surge current**

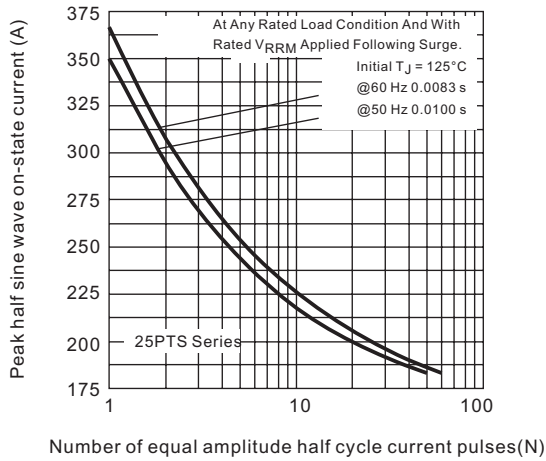

**Fig.6 Maximum non-repetitive surge cCurrent**

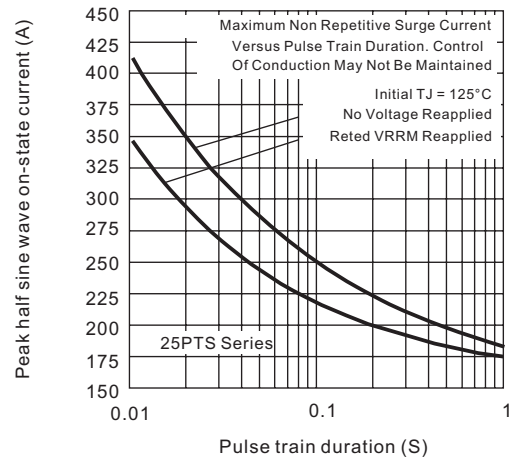

**Fig.7 Forward voltage drop characteristics**

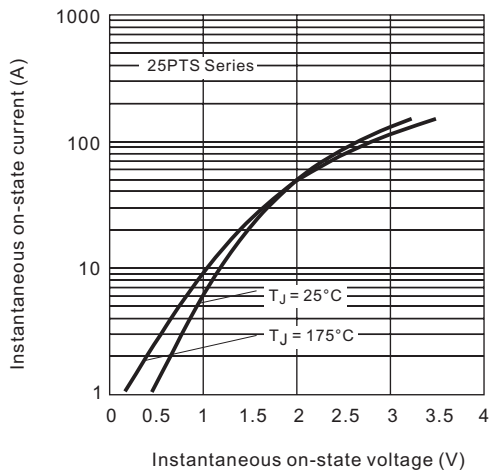

**Fig.8 Thermal Impedance  $Z_{thJC}$  characteristics**

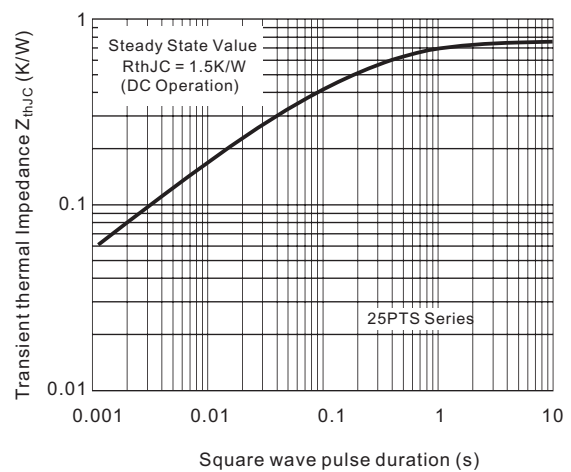

**Fig.9 Gate characteristics**

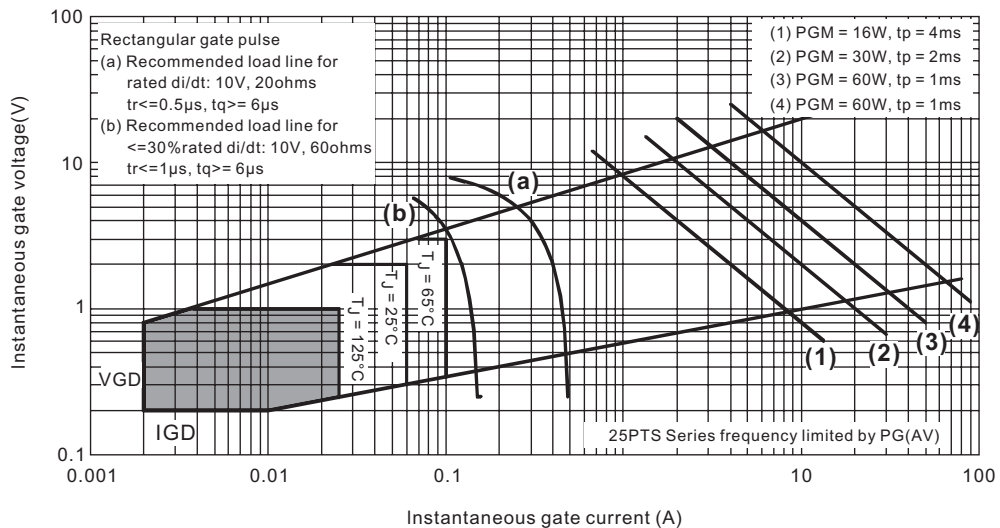

### ORDERING INFORMATION TABLE

Device code	<b>25</b>	<b>PT</b>	<b>12</b>	<b>S</b>	<b>M</b>
	①	②	③	④	⑤

- 1** - Current Code
- 2** - PT for SCR series
- 3** - Voltage code × 100 = VRRM (see Voltage Ratings table)
- 4** - S for stud type
- 5** - None = Stud base TO-208AA (TO-48) 1/4"-28 UNF-2A  
M = Stud base TO-208AA (TO-48) M6×1

### GLASS - METAL SEAL

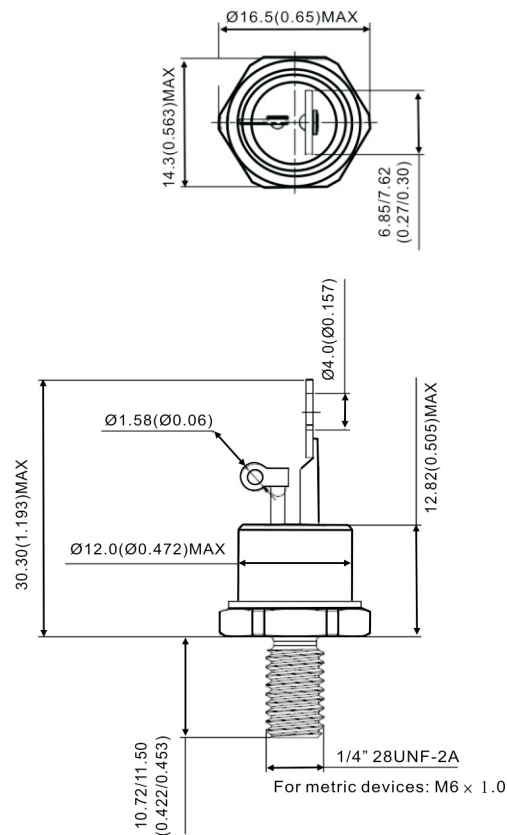

All dimensions in millimeters (inches)